

Actuated Valves and Actuators

Type 03343 - Actuated Globe Valve



Cryogenic-Globe Valves with Pneumatic Actuator, class 150

Stainless steel body and topwork
 Actuator - air opens, spring closes or contrary
 "live loaded" gland packing
 "cleaned and degreased for oxygen service" - the actuator is not cleaned and degreased for oxygen

Part No. 03343.X.*011

Flanged connection acc. to ASME B16.5 class 150

Available accessories:

- Solenoid valve
- Limit switch
- Electropneumatic positioner etc.

Available options - on request only:

- Actuator - "cleaned and degreased for oxygen service"
- Electric actuator
- Valve with check disc
- Valve with control disc (tapered design)



Applications:

Approved for air gases, vapours and cryogenic liquefied gases incl. LNG.
 Working temperature: -196°C / -321°F (77K) up to +120°C / +248°F (393K)

Materials	DIN EN	ASTM
1 Body	1.4308	A 351 CF8
2 Valve seal up to DN50	PTFE / Carbon filled (25%)	
2a Valve seal from DN65	PTFE	
3 Disc	1.4301	A 276 Grade 304
4 Bonnet gasket	PTFE	
5 Headpiece	1.4301	A 276 Grade 304
6 Bolts	1.4301/A2	A 194 B8
7 Elongation tube	1.4541	A 213 TP 321
8 Stem	1.4301	A 276 Grade 304
9 Gland packing	Graphite / PTFE / MICA	
10 Gland nut	1.4305	A 276 Grade 303
11 Pillars	1.4404	A 276 Grade 316L
12 Bush	CW452K	B 159 UNS C51900

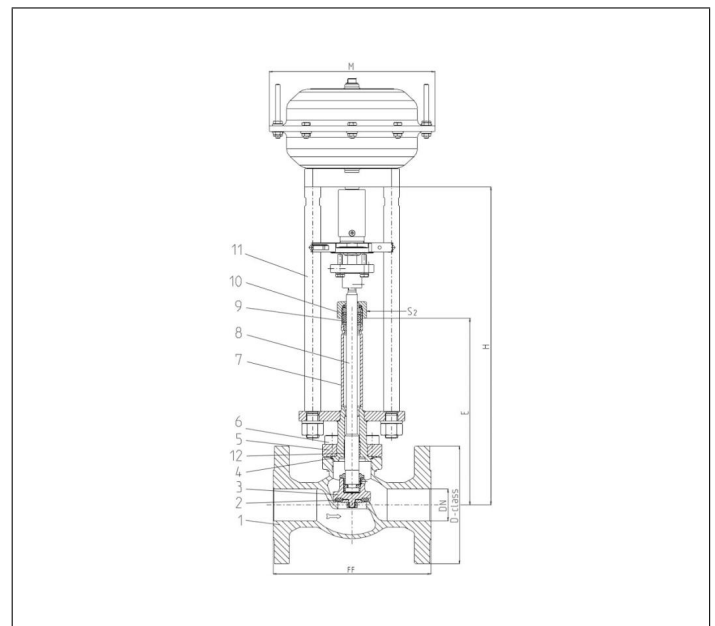

Type 03343 - Standard design	Technical data									
Nominal size	DN	15	20	25	40	50	65	80	100	150
Dimension code - Flange ASME B16.5 class 150	.X.	0400	0600	1000	1400	2000	2400	3000	4000	6000
Flange-Ø	D-class	90	100	110	125	150	180	190	230	280
Face-to-face dimension	FF	140	150	160	200	230	290	310	350	577
Height	H	370	370	370	420	425	510	575	635	685
Length	E	195	200	200	230	235	300	300	300	300
Actuator-Ø	M	dependent on actuator								
Wrench size across flats	S ₂	30	30	30	36	36	36	36	41	41
Weight w/o actuator	ca. kg	4.6	6.5	8.5	12.0	16.0	30.0	36.0	53.0	87.0
*Kvs-Value	m ³ /h	4.3	6.7	11.5	22.6	37.1	71.1	104.0	170.0	350.0
*Cv-Value	gal/min	5.0	7.8	13.4	26.3	43.2	82.9	121.3	198.3	408.4
Stroke	mm	10	7	9	11	15	23	23	30	40

Dimensions in mm. Compliance of tightness requirements acc. to EN 1626 for DN150 up to 20 bar differential pressure. In the range of >20-40 bar, 350-700ml per second (1 bar, 20°C [68°F]) are reached. * These figures refer to measurements for the flow direction.