

# Changeover Valves

## Type 06510 - Diverter Valve



**Cryogenic Diverter Valves, bronze, PN50**  
for the installation of two safety valves,  
provided for bursting disc connections,  
"cleaned and degreased for oxygen service"

**Part No. 06510.X.0000**

Female thread connection (G) acc. to ISO 228/1

**Part No. 06510.X.6\*\*\***

Female thread connection NPT acc. to ANSI B 1.20.1

Available Options - on request only:

- Two extra test connections 1/4" edgeways
- Inlet: female thread (GW) 3/4"
- Outlet GA<sub>1</sub> with installed locking sleeve for easy positioning of safety valves
- Combination of different outlet threads GA<sub>1</sub> - GA<sub>2</sub>
- **Safety lock (Part No. 55394.0162.0765)**

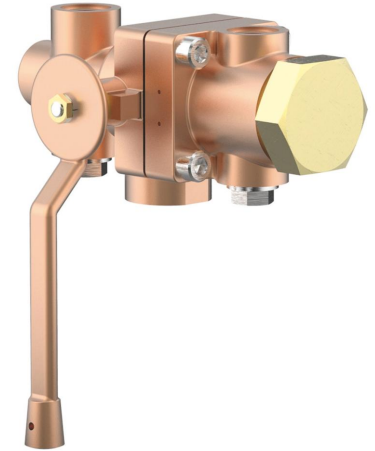

**Applications:**

Approved for air gases, vapours and cryogenic liquefied gases incl. LNG.  
Working temperature: -196°C / -321°F (77K) up to +120°C / +248°F (393K)

Materials	DIN EN	ASTM
1 Body I	CC491K	B 62 UNS C83600
2 Body II	CC491K	B 62 UNS C83600
3 Ball	1.4571	A 276 Grade 316Ti
4 Seat rings	PCTFE	
5 Bush	CW614N	B 283 UNS C38500
6 Spring plates	1.4571	A 313 Grade 316Ti
7 Spring clamp	CW614N	B 283 UNS C38500
8 Thread ring	CW614N	B 283 UNS C38500
9 Plug	CW614N	B 283 UNS C38500
10 Stem	1.4301	A 276 Grade 304
11 Gland packing	Graphite / PTFE	
12 Lever	CC491K	B 62 UNS C83600

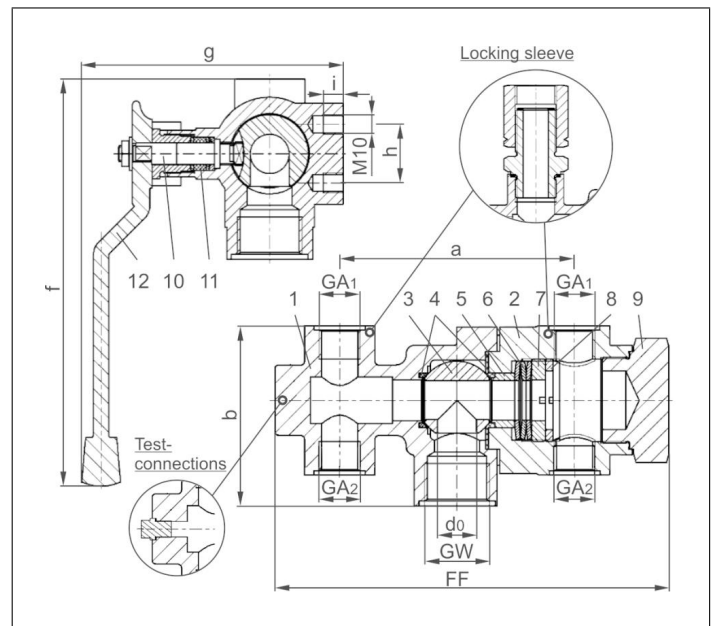

Type 06510 - Standard design	Technical Data		
Nominal Size	DN	20	20
Dimension code	.X.	2004	2006
Flow diameter	d <sub>0</sub>	20	20
Inlet	GW	1	1
Outlet	GA <sub>1</sub>	1/2	3/4
Outlet	GA <sub>2</sub>	1/2	1/2
Face-to-face dimension	FF	201	201
Length	a	120	120
Height	b	92	92
Length	f	208	208
Length	g	134	134
Length	h	30	30
Thread depth	i	10	10
Weight	ca. kg	4.8	4.7
Kvs - Value, one side open	m <sup>3</sup> /h	7.7	7.7
Cv - Value, one side open	gal /min	9.2	9.2

Dimensions in mm.

**Important:**

The valves must be fixed at the provided threads M10.