

Changeover Valves

Type 06510 - Diverter Valve



Cryogenic Diverter Valves, bronze, PN50

for the installation of two safety valves,
provided for bursting disc connections,
"cleaned and degreased for oxygen service"

Part No. 06510.X.0008

Inlet: union type braze fitting for pipe outside diameter 26.9mm

Outlet: female thread connection (G) acc. to ISO 228/1

Part No. 06510.X.000*

Inlet: union type butt weld fitting, when order please indicate pipe diameter

Outlet: female thread connection (G) acc. to ISO 228/1

Part No. 06510.X.6026

Inlet: union type butt weld fitting for pipe 33.4mm S10

Outlet: female thread connection NPT acc. to ANSI B 1.20.1

Available options - on request only:

- Two extra test connections 1/4" edgeways
- Inlet: union type braze or butt weld fitting for other pipe diameter
- Outlet GA₁ with installed locking sleeve for easy positioning of safety valves
- Combination of different outlet threads GA₁ - GA₂
- **Safety lock (Part No. 55394.0162.0765)**

Applications:

Approved for air gases, vapours and cryogenic liquefied gases incl. LNG.

Working temperature: -196°C / -321°F (77K) up to +120°C / +248°F (393K)

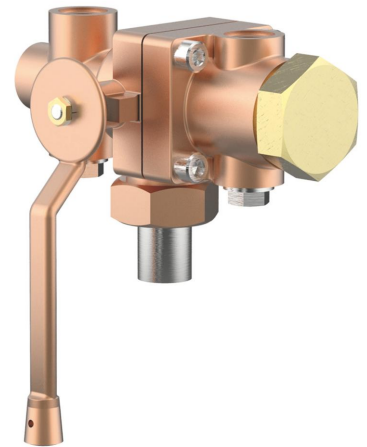

Materials	DIN EN	ASTM
1 Body I	CC491K	B 62 UNS C83600
2 Body II	CC491K	B 62 UNS C83600
3 Ball	1.4571	A 276 Grade 316Ti
4 Seat rings	PCTFE	
5 Bush	CW614N	B 283 UNS C38500
6 Spring plates	1.4571	A 313 Grade 316Ti
7 Spring clamp	CW614N	B 283 UNS C38500
8 Thread ring	CW614N	B 283 UNS C38500
9 Plug	CW614N	B 283 UNS C38500
10 Stem	1.4301	A 276 Grade 304
11 Gland packing	Graphit / PTFE	
12 Lever	CC491K	B 62 UNS C83600
13 Braze fitting	CC493K	B 505 UNS C93200
13a Weld fitting	1.4301	A 276 Grade 304
14 Union nut	CC493K	B 505 UNS C93200

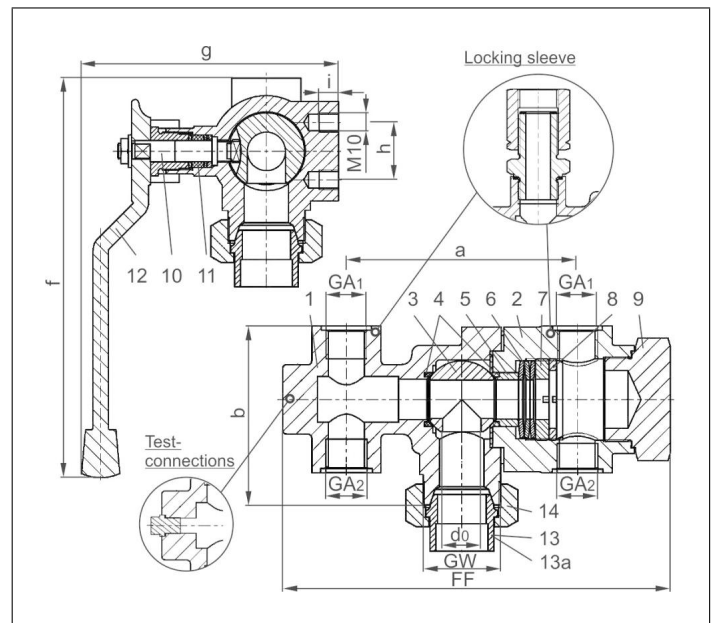

Type 06510 - Standard design	Technical data		
Nominal size	DN	20	20
Dimension code	.X.	2040	2060
Flow diameter	d ₀	20	20
Inlet	GW	M40x2	M40x2
Outlet	GA ₁	1/2	3/4
Outlet	GA ₂	1/2	1/2
Face-to-face dimension	FF	201	201
Length	a	120	120
Height	b	92	92
Length	f	208	208
Length	g	134	134
Length	h	30	30
Thread depth	i	10	10
Wrench size across flats	S ₁	50	50
Weight	ca. kg	5.1	5.0
Kvs - Value, one side open	m ³ /h	7.7	7.7
Cv - Value, one side open	gal /min	9.2	9.2

Dimensions in mm.

Important:

The valves must be fixed at the provided threads M10.