

Safety Valves

Type 06810, Type 06815



Safety Valves, angle type, stainless steel, type tested, TÜV-SV.1130. S/G/L

Standard safety valve
 metal to metal seated, "cleaned and degreased for oxygen service"
 closed bonnet, gastight cap or lifting device
 Inlet: male thread type G (BSPP) acc. to ISO 228/1
 Outlet: female thread type G (BSPP) acc. to ISO 228/1

Part No. 06810.X.000000M (Pmax 550.0 bar)
Part No. 06810.X.000000H (Pmax 550.0 bar) stellited version
 with gastight cap

Part No. 06815.X.000000M (Pmax 300.0 bar)
Part No. 06815.X.000000H (Pmax 300.0 bar) stellited version
 with lifting device

Available options - on request only:
 · Flange-, NPT- or Tri-Clamp connection for in- and outlet
 · Inlet: Cone & thread connection for d0 6mm - 9M 13/16"-16 UN or 12M 3/4" - 14NPS



Applications:

Provided as safety device for protection against excessive pressure in gas cylinders and pressure vessels.
 Approved for gases, vapours and liquids. Working temperature: -270°C / -454°F (3K) up to +400°C / +752°F (673K)
 Pressure-temperature must be observed, suitable for horizontal installation from 20 bar up to 300 bar

Materials	DIN EN	ASME/ASTM
1 Outlet body	1.4408	A 351 CF 8M
2 Inlet body	1.4571	A 276 Grade 316Ti
3 Disc	1.4571	A 276 Grade 316Ti
5 Stem	1.4404	A 276 Grade 316L
6 Bonnet	1.4408	A 351 CF8M
7 Spring	1.4571	A 313 Grade 316Ti
8 Cap	1.4408	A 351 CF8M
9 Lifting cap	1.4408	A 351 CF8M
10 Lever	1.4301	A 276 Grade 304
Spare Parts		
2 Inlet body	1.4571	316Ti
3 Disc	1.4571	316Ti
3.1 Split pin	1.4310	301
11 Gasket	Graphite	
12 Gasket	PTFE	
13 Gasket	PTFE	
14 O-ring	FPM (VITON)	

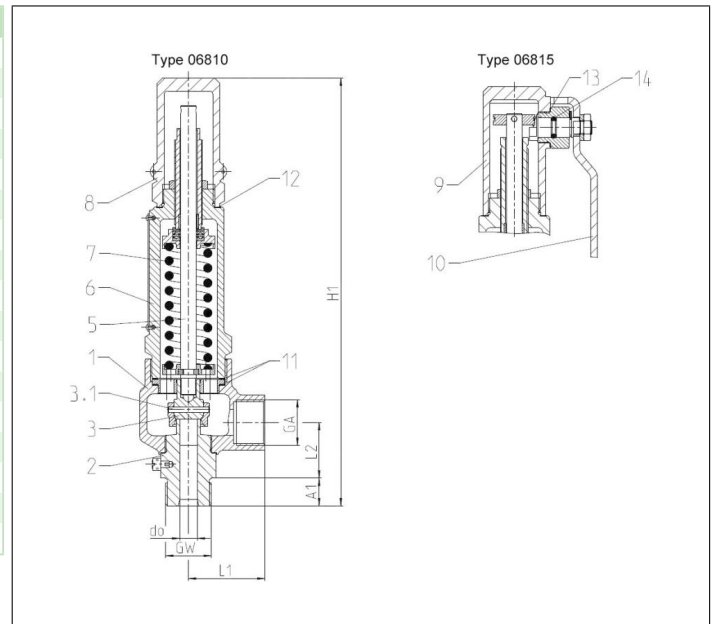

Type 06810, 06815	Technical data							
Nominal size	GW	1/2	1/2	3/4	3/4	1/2	1/2	3/4
Orifice	d ₀	6.0	6.0	6.0	6.0	10.0	10.0	10.0
Dimension code	.X.	0622	0623	0632	0633	1022	1023	1033
Set pressure range	bar	30-400	30-400	30-550	30-550	0.5-180	0.5-180	0.5-180
Outlet	GA	1/2	3/4	1/2	3/4	1/2	3/4	3/4
Height	H ₁	245	245	247	247	245	245	245
Length	L ₁	44	44	44	44	44	44	44
Length	L ₂	32	32	32	32	32	32	32
Length	A ₁	14	14	16	16	14	14	16
Weight 06810	ca. kg	1.8	1.8	1.8	1.8	1.8	1.8	1.8
Weight 06815	ca. kg	2.0	2.0	2.0	2.0	2.0	2.0	2.0
Coeff. of discharge gases, vapours	α _w	0.52	0.52	0.52	0.52	0.5	0.5	0.5
Coeff. of discharge fluids	α _w	0.42	0.42	0.42	0.42	0.5	0.5	0.5

Dimensions in mm.

Safety Valves

Type 06810, Type 06815



Discharge capacities

Calculation of flow rate acc. to AD2000-Merkblatt A2 / DIN EN ISO 4126-1

Medium:

A = Saturated steam in kg/h

B = Air in m³/h at 0°C and 1013,25 mbar

C = Water in kg/h at 20°C

The capacity indicated below is for a fully opened valve.

d_0 - orifice

A_0 - flow area

Set pressure in bar (g)	GW	1/2			3/4		
	d_0 (mm)	6.0			6.0		
	A_0 (mm ²)	28.27			28.27		
Medium	A	B	C	A	B	C	
30.0	254	350	3473	254	350	3473	
40.0	336	468	4011	336	468	4011	
60.0	503	708	4912	503	708	4912	
80.0	670	953	5672	670	953	5672	
100.0	845	1203	6341	845	1203	6341	
120.0	1032	1451	6947	1032	1451	6947	
140.0	1230	1703	7503	1230	1703	7503	
160.0	1437	1952	8021	1437	1952	8021	
180.0	1688	2194	8508	1688	2194	8508	
200.0	2215	2429	8968	2215	2429	8968	
220.0	-	2659	9406	-	2659	9406	
240.0	-	2893	9824	-	2893	9824	
260.0	-	3133	10225	-	3133	10225	
280.0	-	3374	10611	-	3374	10611	
300.0	-	3614	10983	-	3614	10983	
320.0	-	-	-	-	3854	11344	
340.0	-	-	-	-	4094	11693	
360.0	-	-	-	-	4334	12032	
380.0	-	-	-	-	4575	12361	
400.0	-	-	-	-	4815	12683	
420.0	-	-	-	-	5055	12996	
440.0	-	-	-	-	5295	13302	
460.0	-	-	-	-	5535	13601	
480.0	-	-	-	-	5776	13893	
500.0	-	-	-	-	6016	14180	
520.0	-	-	-	-	6256	14460	
550.0	-	-	-	-	6616	14872	

Pressure-Temperature Rating

Maximum allowable set pressure safety valve type 0681X

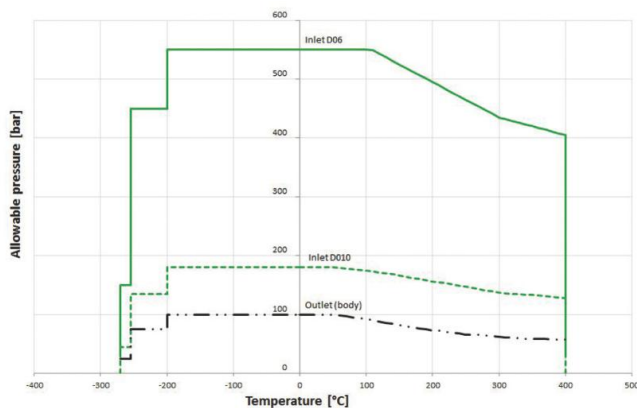

Safety Valves

Type 06810, Type 06815



Discharge capacities

Calculation of flow rate acc. to AD2000-Merkblatt A2 / DIN EN ISO 4126-1

Medium:

A = Saturated steam in kg/h

B = Air in m³/h at 0°C and 1013,25 mbar

C = Water in kg/h at 20°C

The capacity indicated below is for a fully opened valve.

d_0 - orifice

A_0 - flow area

Set pressure in bar (g)	GW	1/2 & 3/4		
	d_0 (mm)	10.0		
	A_0 (mm ²)	78.5		
	Medium	A	B	C
0.5		33	40	1549
1.0		44	55	2097
2.0		68	86	2966
3.0		90	116	3632
4.0		113	145	4194
5.0		135	175	4689
6.0		157	205	5137
7.0		179	234	5548
8.0		201	264	5931
9.0		223	294	6291
10.0		245	324	6631
12.0		288	384	7264
14.0		331	443	7846
16.0		374	503	8388
18.0		418	562	8897
20.0		461	627	9378
25.0		569	777	10485
30.0		678	936	11486
35.0		788	1087	12406
40.0		899	1249	13262
45.0		1009	1402	14067
50.0		1120	1568	14828
60.0		1343	1890	16243
70.0		1566	2216	17545
80.0		1791	2546	18756
90.0		2020	2878	19894
100.0		2256	3212	20970
120.0		2756	3877	22971
130.0		3018	4197	23909
140.0		-	4549	24812
160.0		-	5213	26525
180.0		-	5861	28134